

REV	DESCRIPTION	DATE
1.00	INITIAL DESIGN	2018/01/29
1.10	UPDATE DRAWING	2024/10/08

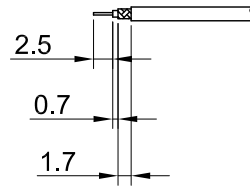

RECOMMENDED STRIP LENGTHS

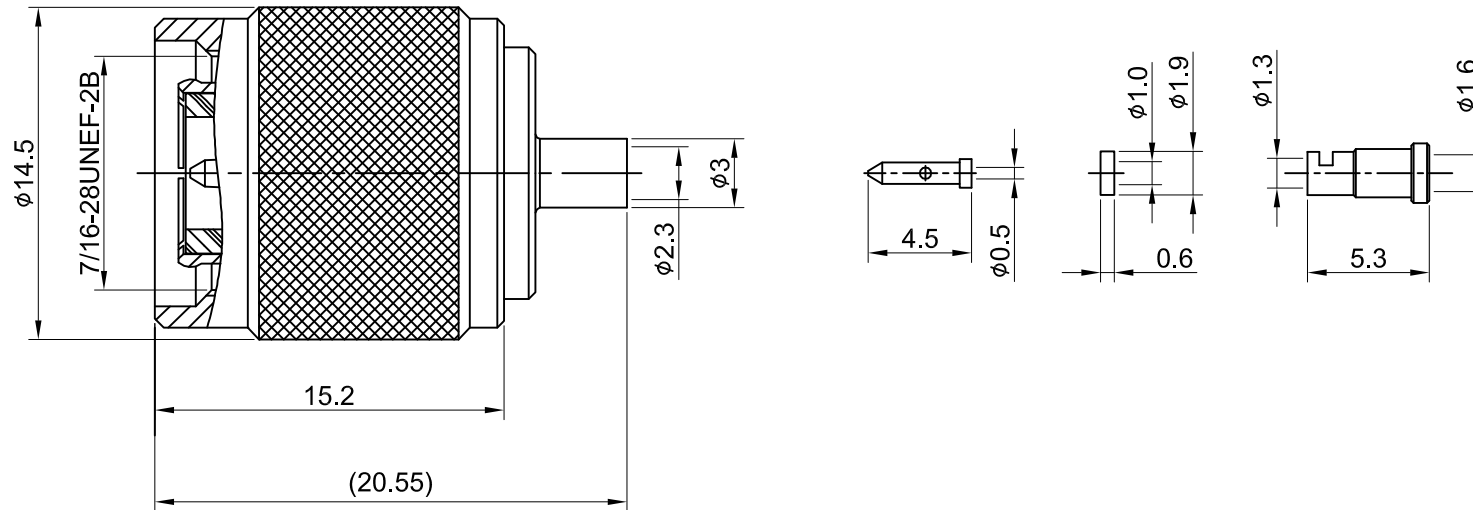

MECHANICAL DATA
TEMPERATURE RANGE : -65°C ~ + 165°C

ELECTRICAL DATA
FREQUENCY RANGE: DC~6GHZ
IMPEDANCE : 50Ω
VSWR : 1.5 MAX.
WORKING VOLTAGE : AC 500V
WITHSTANDING VOLTAGE : AC 1500V
INSULATION RESISTANCE : 5000 MΩ MIN

09	SHELL	BRASS	NICKEL	1
08	INSULATOR GASKET	TEFLON	NONE	1
07	CENTER PIN	P.BRONZE	GOLD	1
06	BULLET CONTACT	BRASS	GOLD	1
05	FERRULE	BRASS	GOLD	1
04	GASKET	SILICONE RUBBER	RED	1
03	INNER RETAINING RING	BRASS	NONE	1
02	INSULATOR	TEFLON	NONE	1
01	BODY	BRASS	NICKEL	1
NO	DESCRIPTION	MATERIAL	FINISH	Q'TY

TITLE		DRAWN BY: Kelly		2024/10/08
TNC(M)st.crimp for 1.37mm cable		CHK'D BY: Mindy		2024/10/08
DWG NO. C17CA3F137002G		GENERAL TOLERANCES		
CUST. P/N: N/A DWG NO: N/A		.X ±0.2 .XX ±0.2 .XXX ±0.2 ANGLES N/A		
SHEET 1 of 1	Unit: mm	DA2410070017		REV. 1.10